

TECHNICAL DATA

Material	Nickel plated brass
Thread	Metric, taper and parallel
Size	M5 ÷ G1/2
Max. pressure	60 bar
Recommended tubes materials	Polyamide, polyethylene, polyurethane

TAPER STRAIGHT MALE

5

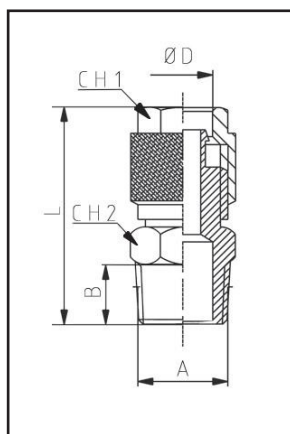

TYPE	L	A	B	ØD	CH1	CH2	q.tà
RC1-DM-4/01	23,8	R1/8	8	4/2,7	8	12	50
RC1-DM-5/01	25	R1/8	8	5/3	8	12	50
RC1-DM-6/01	27,5	R1/8	8	6/4	12	12	50
RC1-DM-6/02	31	R1/4	11	6/4	12	14	50
RC1-DM-6/03	31,5	R3/8	11,5	6/4	12	17	50
RC1-DM-8/01	27,5	R1/8	8	8/6	14	12	50
RC1-DM-8/02	31	R1/4	11	8/6	14	14	50
RC1-DM-8/03	31,5	R3/8	11,5	8/6	14	17	50
RC1-DM-8/04	34,5	R1/2	14	8/6	14	22	50
RC1-DM-10/01	29,5	R1/8	8	10/8	16	14	50
RC1-DM-10/02	32,5	R1/4	11	10/8	16	14	50
RC1-DM-10/03	33	R3/8	11,5	10/8	16	17	25
RC1-DM-10/04	36	R1/2	14	10/8	16	22	25
RC1-DM-12/03	34,5	R3/8	11,5	12/10	18	17	20
RC1-DM-12/04	37,5	R1/2	14	12/10	18	22	20
RC1-DM-15/04	39,5	R1/2	14	15/12,5	22	22	10

PARALLEL STRAIGHT MALE

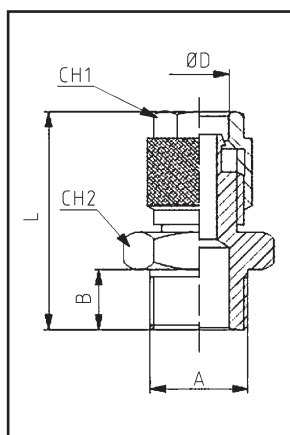

TYPE	L	A	B	ØD	CH1	CH2	q.tà
RC-DM-5/01	23	G1/8	6	5/3	8	14	50
RC-DM-6/01	25,5	G1/8	6	6/4	12	14	50
RC-DM-6/02	28	G1/4	8	6/4	12	17	50
RC-DM-6/03	29	G3/8	9	6/4	12	19	50
RC-DM-8/01	25,5	G1/8	6	8/6	14	14	50
RC-DM-8/02	28	G1/4	8	8/6	14	17	50
RC-DM-8/03	29	G3/8	9	8/6	14	19	50
RC-DM-10/01	27	G1/8	6	10/8	16	14	50
RC-DM-10/02	29,5	G1/4	8	10/8	16	17	50
RC-DM-10/03	30,5	G3/8	9	10/8	16	19	25
RC-DM-10/04	32	G1/2	10	10/8	16	24	25
RC-DM-12/03	32	G3/8	9	12/10	18	19	20
RC-DM-12/04	33,5	G1/2	10	12/10	18	24	20
RC-DM-15/04	35,5	G1/2	10	15/12,5	22	24	10

PARALLEL STRAIGHT FEMALE

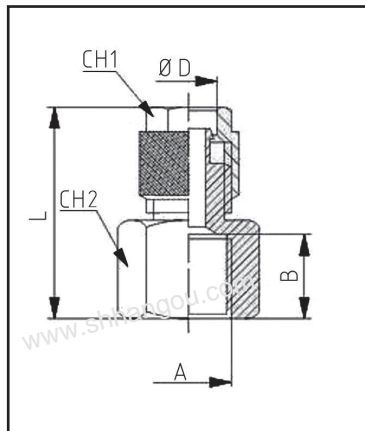

TYPE	L	A	B	ØD	CH1	CH2	q.ty
RC-DF-4/01	21,3	G1/8	8	4/2,7	8	14	50
RC-DF-5/01	22,5	G1/8	8	5/3	8	14	50
RC-DF-6/01	25	G1/8	8	6/4	12	14	50
RC-DF-6/02	29	G1/4	11	6/4	12	17	50
RC-DF-6/03	29,5	G3/8	11,5	6/4	12	20	50
RC-DF-8/01	25	G1/8	8	8/6	14	14	50
RC-DF-9/02	29	G1/4	11	8/6	14	17	50
RC-DF-8/03	29,5	G3/8	11,5	8/6	14	20	50
RC-DF-10/01	26,5	G1/8	8	10/8	16	14	50
RC-DF-10/02	30,5	G1/4	11	10/8	16	17	50
RC-DF-10/03	31	G3/8	11,5	10/8	16	20	25
RC-DF-10/04	34,5	G1/2	14	10/8	16	24	20
RC-DF-12/03	32,5	G3/8	11,5	12/10	18	20	20

BULKHEAD CONNECTOR

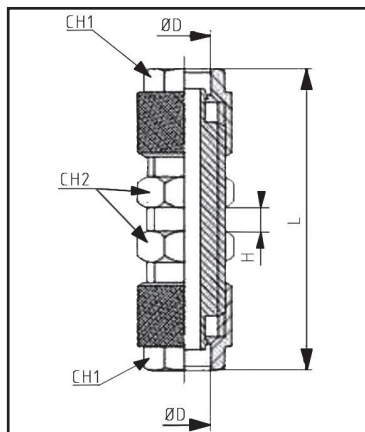

TYPE	L	ØD	H/max	CH1	CH2	q.ty
RC-P4	36,7	4/2,7	8,5	8	8	50
RC-P5	40	5/3	8,5	8	9	50
RC-P6	48	6/4	10,5	12	14	50
RC-P8	48	8/6	10,5	14	16	50
RC-P10	50	10/8	8,5	16	17	25
RC-P12	53	12/10	8,5	18	19	20
RC-P15	58	15/12,5	8,5	22	24	10

5

UNION STRAIGHT

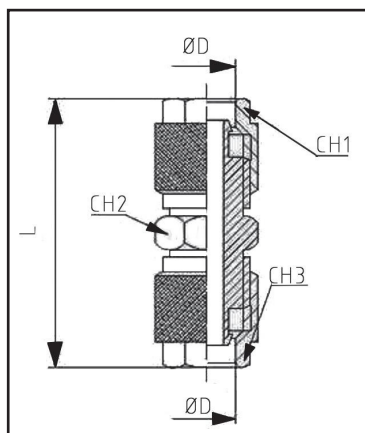

TYPE	L	ØD	CH1	CH2	CH3	q.ty
RC-DI-4	26,1	4/2,7	8	8	8	50
RC-DI-5	28,5	5/3	8	8	8	50
RC-DI-6	34,5	6/4	12	12	12	50
RC-DI-8/6	35	8/6 x 6/4	14	14	12	50
RC-DI-8	35	8/6	14	14	14	50
RC-DI-10	38	10/8	16	16	14	25
RC-DI-12	41	12/10	18	17	18	25
RC-DI-15	45,5	15/12,5	22	22	22	10

TAPER ELBOW MALE

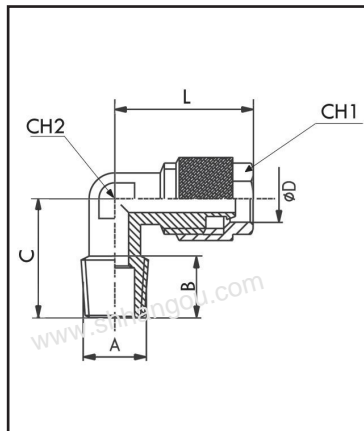

TYPE	L	A	B	C	ØD	CH1	CH2	q.ty
RC1-G-4/01	19,5	R1/8	8	17	4/2,7	8	8	50
RC1-G-5/01	21,5	R1/8	8	17	5/3	8	8	50
RC1-G-6/01	22,5	R1/8	8	17	6/4	12	8	50
RC1-G-6/02	22,5	R1/4	11	20	6/4	12	10	50
RC1-G-6/03	23,5	R3/8	11,5	22,5	6/4	12	11	50
RC1-G-8/01	22,5	R1/8	8	17	8/6	14	10	50
RC1-G-8/02	22,5	R1/4	11	20	8/6	14	10	50
RC1-G-8/03	24	R3/8	11,5	20	8/6	14	11	50
RC1-G-10/01	25,5	R1/8	8	22,5	10/8	16	11	50
RC1-G-10/02	25,5	R1/4	11	18,5	10/8	16	11	50
RC1-G-10/03	25,5	R3/8	11,5	21,5	10/8	16	11	25
RC1-G-10/04	28	R1/2	14	28	10/8	16	17	25
RC1-G-12/02	30	R1/4	11	24	12/10	18	14	20
RC1-G-12/03	30	R3/8	11,5	24,5	12/10	18	14	20
RC1-G-12/04	30,5	R1/2	14	28	12/10	18	17	20
RC1-G-15/04	34	R1/2	14	28	15/12,5	22	17	10

PARALLEL SWIVEL ELBOW WITH O-RING

5

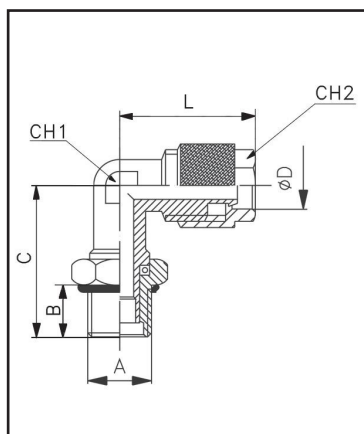

TYPE	L	A	B	C	ØD	CH1	CH2	q.ty
RC-GG-4/01	21,5	G1/8	6	22,5	4/2,7	12	14	50
RC-GG-6/01	22,5	G1/8	6	22,5	6/4	12	14	50
RC-GG-6/02	23,5	G1/4	8	25	6/4	12	17	50
RC-GG-8/01	23,5	G1/8	6	22,5	8/6	14	14	50
RC-GG-8/02	23,5	G1/4	8	25	8/6	14	17	50
RC-GG-10/02	25,5	G1/4	8	25,5	10/8	16	17	25

PARALLEL ELBOW FEMALE

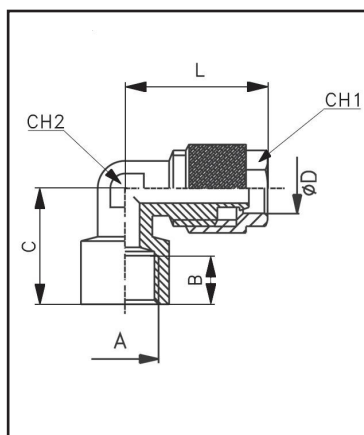

TYPE	L	A	B	C	ØD	CH1	CH2	q.ty
RC-GF-5/01	21,5	G1/8	8	19	5/3	8	10	50
RC-GF-6/01	22,5	G1/8	8	19	6/4	12	10	50
RC-GF-6/02	25	G1/4	10,5	23	6/4	12	11	50
RC-GF-8/01	22,5	G1/8	8	19	8/6	14	10	50
RC-GF-8/02	25	G1/4	10,5	23	8/6	14	11	50
RC-GF-10/02	26	G1/4	11	23,5	10/8	16	13	25
RC-GF-12/03	30,5	G3/8	11,5	28	12/10	18	17	20

UNION ELBOW

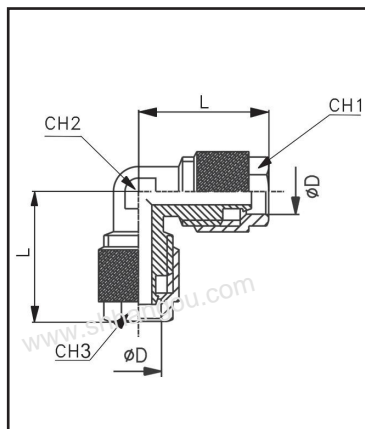

TYPE	L	ØD	CH1	CH2	CH3	q.ty
RC-GI-4	20,3	4/2,7	8	8	8	50
RC-GI-5	21,5	5/3	8	8	8	50
RC-GI-6	21,5	6/4	12	8	12	50
RC-GI-8/6	22,5	8/6	12	10	14	50
RC-GI-8	22,5	8/6	14	10	14	50
RC-GI-10	25,5	10/8	16	11	16	25
RC-GI-12	30	12/10	18	14	18	20
RC-GI-15	34	15/12,5	22	17	22	10

TAPER CENTRAL MALE TEE

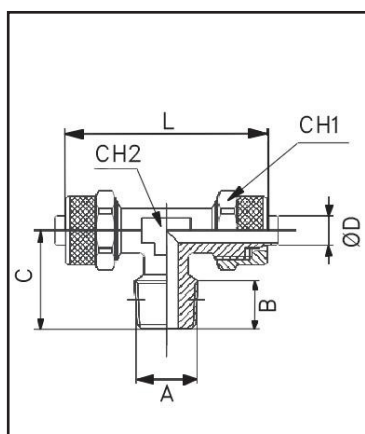

TYPE	L	A	B	C	ØD	CH1	CH2	q.ty
RC1-TC-4/01	40,6	R1/8	8	17	4/2,7	8	8	50
RC1-TC-5/M5	43	M5	4	15	5/3	8	8	50
RC1-TC-5/01	43	R1/8	8	17	5/3	8	8	50
RC1-TC-6/01	45	R1/8	8	17	6/4	11	8	50
RC1-TC-6/02	45,5	R1/4	11	20,5	6/4	11	10	50
RC1-TC-6/03	47	R3/8	11,5	22,5	6/4	12	11	50
RC1-TC-8/01	45,5	R1/8	8	17,5	8/6	14	10	50
RC1-TC-8/02	45,5	R1/4	11	20,5	8/6	14	10	50
RC1-TC-8/03	48	R3/8	11,5	21,5	8/6	14	11	50
RC1-TC-10/01	51	R1/8	8	18,5	10/8	16	11	50
RC1-TC-10/02	51	R1/4	11	21,5	10/8	16	11	50
RC1-TC-10/03	51	R3/8	11,5	22,5	10/8	16	11	25
RC1-TC-10/04	57	R1/2	14	28	10/8	16	17	25
RC1-TC-12/03	60	R3/8	11,5	22,5	12/10	18	14	20
RC1-TC-12/04	61	R1/2	14	28	12/10	18	17	20
RC1-TC-15/04	68	R1/2	14	28	15/12,5	22	17	10

5

PARALLEL SWIVELLING CENTRAL MALE TEE

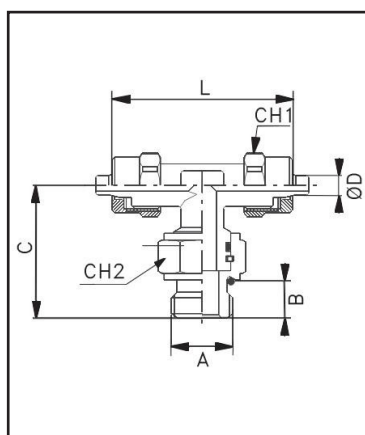

TYPE	L	A	B	C	ØD	CH1	CH2	q.ty
RC-TG-4/01	45	G1/8	6	25,7	4/2,7	8	13	25
RC-TG-6/01	45	G1/8	6	25,7	6/4	12	13	25
RC-TG-6/02	45,5	G1/4	8	29	6/4	12	16	20
RC-TG-8/02	45,5	G1/4	8	28	8/6	14	16	20
RC-TG-10/02	51	G1/4	8	29	10/8	16	16	10

TAPER LATERAL MALE TEE

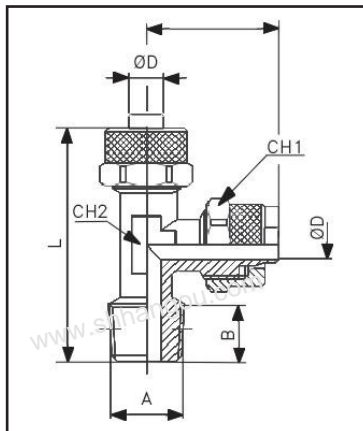

TYPE	L	A	B	C	ØD	CH 1	CH 2	q.ty
RC1-TL-4/01	38	R1/8	8	21,5	4/2,7	8	8	50
RC1-TL-5/M5	36,5	M5	4	21,5	5/3	8	8	50
RC1-TL-5/01	38,5	R1/8	8	21,5	5/3	8	8	50
RC1-TL-6/01	39,5	R1/8	8	22,5	6/4	11	8	50
RC1-TL-6/02	42,5	R1/4	11	22,5	6/4	11	10	50
RC1-TL-6/03	46,5	R3/8	11,5	24	6/4	12	11	50
RC1-TL-8/01	40,5	R1/8	8	22,5	8/6	14	10	50
RC1-TL-8/02	43,5	R1/4	11	22,5	8/6	14	10	50
RC1-TL-8/03	46,5	R3/8	11,5	23,5	8/6	14	11	50
RC1-TL-10/01	44	R1/8	8	25,5	10/8	16	11	50
RC1-TL-10/02	46,5	R1/4	11	25,5	10/8	16	11	50
RC1-TL-10/03	48	R3/8	11,5	25,5	10/8	16	11	25
RC1-TL-10/04	57	R1/2	14	29	10/8	16	17	25
RC1-TL-12/03	54,5	R3/8	11,5	30	12/10	18	14	20
RC1-TL-12/04	58,5	R1/2	14	30,5	12/10	18	17	20
RC1-TL-15/04	62	R1/2	14	34	15/12,5	22	17	10

UNION TEE

5

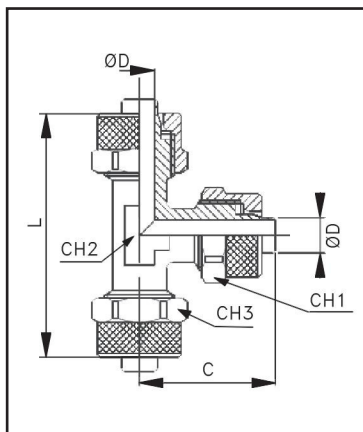

TYPE	L	C	ØD	CH 1	CH 2	CH 3	q.ty
RC-TI-4	20,3	20,3	4/2,7	8	8	8	50
RC-TI-5	43	21,5	5/3	8	8	8	50
RC-TI-6	45	22,5	6/4	12	8	12	50
RC-TI-8/6	45	22,5	8/6	14	10	14	50
RC-TI-8	45	22,5	8/6	12	10	14	50
RC-TI-10	51	25,5	10/8	16	11	16	25
RC-TI-12	60	30	12/10	18	14	18	20
RC-TI-15	68	34	15/12,5	22	17	22	10

CROSS CONNECTOR

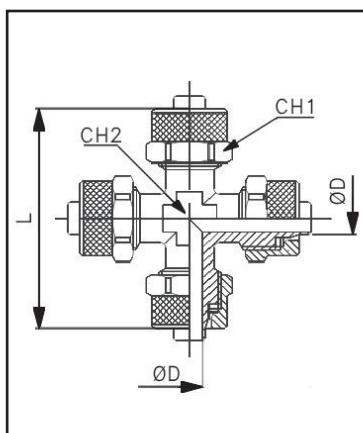
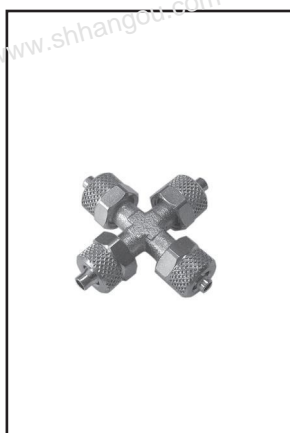

TYPE	L	ØD	CH 1	CH 2	q.ty
RC-C-5	43	5/3	8	8	20
RC-C-6	45	6/4	12	8	20
RC-C-8	45	8/6	14	10	20
RC-C-10	51	10/8	16	11	10

SINGLE BANJO STEM

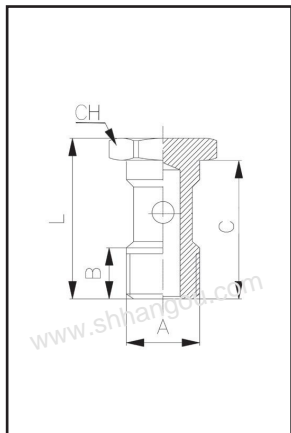

TYPE	L	A	B	C	CH	q.ty
RC-VBS-M5	18	M5	6	14,5	8	50
RC-VBS-M6	18,5	M6	6	14,5	8	50
RC-VBS-01	27	G1/8	8	23	14	50
RC-VBS-02	29,5	G1/4	11	25	17	50

DOUBLE BANJO STEM

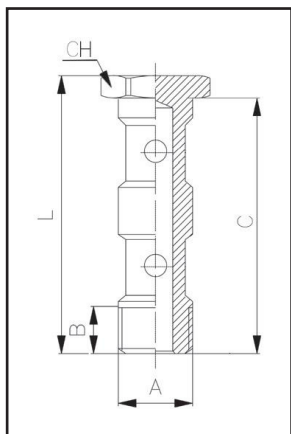

TYPE	L	A	B	C	CH	q.ty
RC-VBD-01	43	G1/8	8	39	14	50
RC-VBD-02	45,5	G1/4	11	41	17	50

5

LOCKING NUT

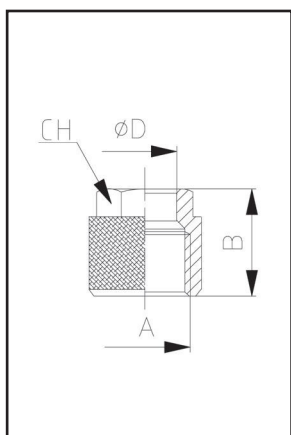

TYPE	A	B	D	CH	q.ty
RC-DS-4/M6	4/2,7	8,1	M6x0,5	8	50
RC-DS-6/M8	6/4	9	M8x0,75	9	50
RC-DS-6/M10	6/4	10,5	M10x1	12	50
RC-DS-8/M12	8/6	10,5	M12x1	14	50
RC-DS-10/M14	10/8	11,5	M14x1	16	25
RC-DS-12/M16	12/10	13	M16x1	18	20
RC-DS-15/M20	15/12,5	15,5	M20x1	22	10

SINGLE BANJO BODY

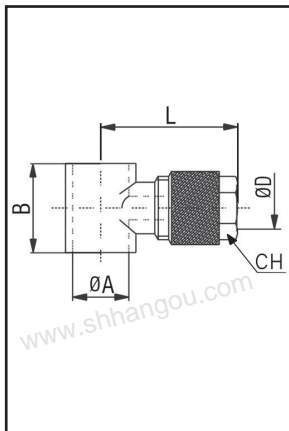

TYPE	L	ØA	B	ØD	CH	q.ty
RC-CBS-4/M5	15,8	M5	9	4/2,7	8	50
RC-CBS-4/M6	15,8	M6	9	4/2,7	8	50
RC-CBS-4/01	21,3	G1/8	14,5	4/2,7	8	50
RC-CBS-5/M5	17	M5	9	5/3	8	50
RC-CBS-5/01	22,5	G1/8	14,5	5/3	8	50
RC-CBS-6/M5	18	M5	9	6/4	9	50
RC-CBS-6/01	24	G1/8	14,5	6/4	12	50
RC-CBS-6/02	26	G1/4	14,5	6/4	12	50
RC-CBS-8/01	24	G1/8	14,5	8/6	14	50
RC-CBS-8/02	26	G1/4	14,5	8/6	14	50
RC-CBS-10/02	27,5	G1/4	14,5	10/8	16	25

DOUBLE BANJO BODY

5

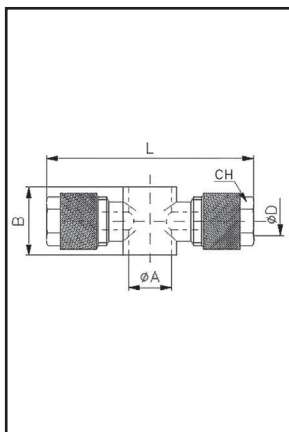

TYPE	L	ØA	B	ØD	CH	q.ty
RC-CBD-4/01	42,6	G1/8	14,5	4/2,7	8	50
RC-CBD-5/01	45	G1/8	14,5	5/3	8	50
RC-CBD-6/01	48	G1/8	14,5	6/4	12	50
RC-CBD-6/02	52	G1/4	14,5	6/4	12	50
RC-CBD-8/01	48	G1/8	14,5	8/6	14	50
RC-CBD-8/02	52	G1/4	14,5	8/6	14	50
RC-CBD-10/02	55	G1/4	14,5	10/8	16	25

FEMALE BANJO BODY

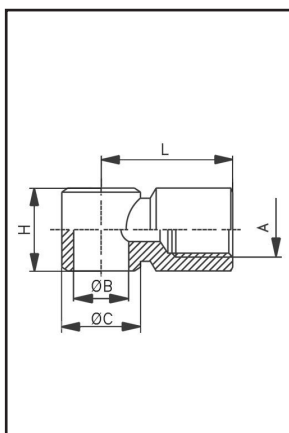

TYPE	L	A	ØB	ØC	H	q.ty
RC-CBF-01	20	G1/8	G1/8	14	14,5	25
RC-CBF-02	24,5	G1/4	G1/4	18	17,5	25
RC-CBF-03	29	G3/8	G3/8	21	21	20

QUICK COUPLER WITH SPRING

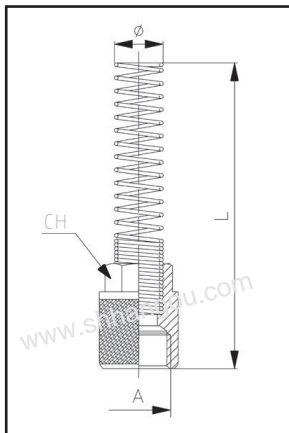

TYPE	L	A	Ø	CH	q.ty
RC-G-6/M10	95	M10x1	6/4	12	10
RC-G-8/M12	93,5	M12x1	8/6	14	10
RC-G-10/M14	96,5	M14x1	10/8	16	10
RC-G-12/M16	106	M16x1	12/10	18	10

TAPER FIXED STRAIGHT MALE ADAPTER + NUT WITH SPRING

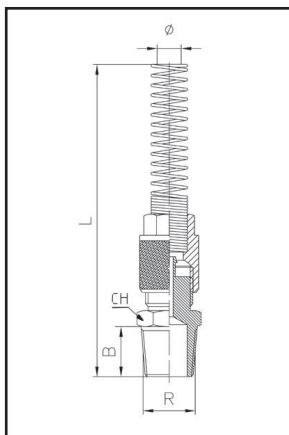

TYPE	L	B	R	Ø	CH	q.ty
RC1-DFM-6/01	109,5	8	1/8	6/4	12	10
RC1-DFM-6/02	113	11	1/4	6/4	14	10
RC1-DFM-8/01	124,5	8	1/8	8/6	12	10
RC1-DFM-8/02	128	11	1/4	8/6	14	10
RC1-DFM-8/03	128,5	11,5	3/8	8/6	17	10
RC1-DFM-8/04	131,5	14	1/2	8/6	22	10
RC1-DFM-10/01	123	8	1/8	10/8	14	10
RC1-DFM-10/02	125	11	1/4	10/8	14	10
RC1-DFM-10/03	125,5	11,5	3/8	10/8	17	10
RC1-DFM-10/04	130	14	1/2	10/8	22	10
RC1-DFM-12/03	134,5	11,5	3/8	12/10	17	10
RC1-DFM-12/04	140	14	1/2	12/10	22	10

5

PARALLEL FIXED STRAIGHT MALE ADAPTER + NUT WITH SPRING

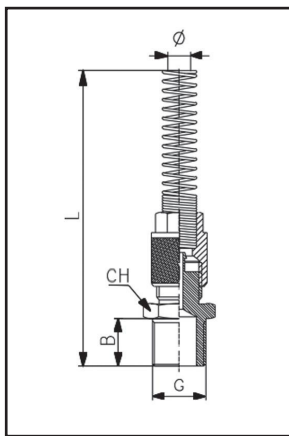

TYPE	L	B	G	Ø	CH	q.ty
RC-DFM-6/01	111	6	1/8	6/4	13	10
RC-DFM-6/02	111	8	1/4	6/4	16	10
RC-DFM-6/03	112	9	3/8	6/4	19	10
RC-DFM-6/04	113	10	1/2	6/4	24	10
RC-DFM-8/01	110	6	1/8	8/6	14	10
RC-DFM-8/02	111	8	1/4	8/6	16	10
RC-DFM-8/03	112	9	3/8	8/6	19	10
RC-DFM-8/04	113	10	1/2	8/6	24	10
RC-DFM-10/01	116	6	1/8	10/8	14	10
RC-DFM-10/02	117	8	1/4	10/8	16	10
RC-DFM-10/03	118,5	9	3/8	10/8	19	10
RC-DFM-10/04	119	10	1/2	10/8	24	10
RC-DFM-12/03	129	9	3/8	12/10	19	10
RC-DFM-12/04	130	10	1/2	12/10	24	10

TAPER SWIVEL STRAIGHT MALE ADAPTER + NUT WITH SPRING

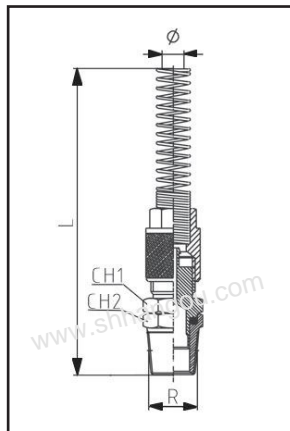

TYPE	L	R	Ø	CH1	CH2	q.ty
RC1-DGM-6/01	116,9	1/8	6/4	15	13	10
RC1-DGM-6/02	118,9	1/4	6/4	15	13	10
RC1-DGM-8/01	122,4	1/8	*8/5	16	16	10
RC1-DGM-8/02	124,4	1/4	*8/5	13	13	10
RC1-DGM-8/01A	122,4	1/8	8/6	16	16	10
RC1-DGM-8/02A	124,4	1/4	8/6	16	16	10
RC1-DGM-10/02	132,4	1/4	*10/6,5	16	16	10
RC1-DGM-10/02A	132,4	1/4	10/8	13	13	10
RC1-DGM-12/03	141,9	3/8	*12/8	16	16	10
RC1-DGM-12/03A	141,9	3/8	12/10	16	16	10

* Specific dimensions for PU tube

PARALLEL SWIVEL STRAIGHT MALE ADAPTER + NUT WITH SPRING

5

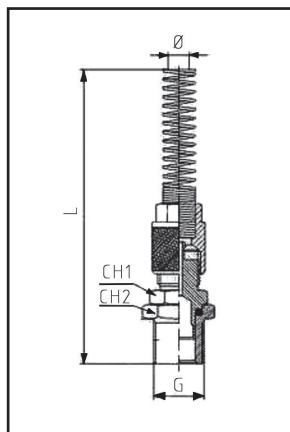

TYPE	L	G	Ø	CH1	CH2	q.ty
RC-DGM-6/01	116,9	1/8	6/4	13	13	10
RC-DGM-6/02	118,9	1/4	6/4	13	13	10
RC-DGM-8/01	122,4	1/8	*8/5	16	16	10
RC-DGM-8/02	124,4	1/4	*8/5	13	13	10
RC-DGM-8/01A	122,4	1/8	8/6	16	16	10
RC-DGM-8/02A	124,4	1/4	8/6	16	16	10
RC-DGM-10/02	132,4	1/4	*10/6,5	16	16	10
RC-DGM-10/02A	132,4	1/4	10/8	13	13	10
RC-DGM-12/03	141,9	3/8	*12/8	16	16	10
RC-DGM-12/03A	141,9	3/8	12/10	16	16	10

* Specific dimensions for PU tube

WASHER

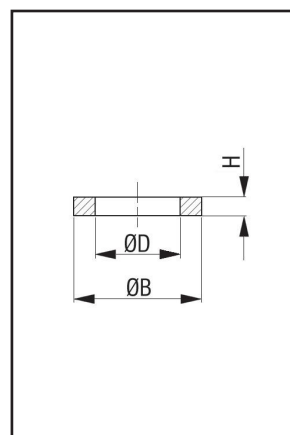

TYPE	ØB	ØD	H	-	q.ty
RO-RD-M5	7,7	5,3	1	M5	100
RO-RD-01	13	10,2	1,5	G1/8	100
RO-RD-02	17,9	13,4	2	G1/4	100
RO-RD-03	21,8	17,1	2	G3/8	100
RO-RD-04	26,5	21,3	2	G1/2	100
RO-RD-06	32,4	26,7	2	G3/4	100

For banjo stem type RC-VBS, RO-VBS and RO-VBD, order No. 2 spacers type RO-RD, to be fitted as follow: one under the head of the screw, and one under the last banjo.

Spacer for RO-VB and RC-VBD*					
TYPE	ØB	ØD	H	-	q.ty
RO-DIS-01	14	10,2	5	G1/8	50
RO-DIS-02	17,5	13,2	5	G1/4	50

* To be fitted between the two rings.

UNIDIRECTIONAL FLOW REGULATOR FOR VALVE (IN)

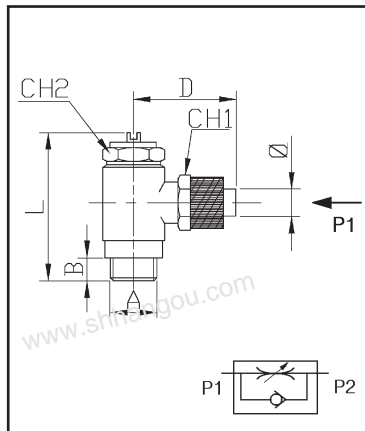

TYPE	L	A	B	D	Ø	NI/min*	CH1	CH2	q.ty
RC-RV-5/M5	24,5	M5	4	15	5/3	45	8	8	25
RC-RV-5/01	31,5	G1/8	5,5	23	5/3	310	8	14	25
RC-RV-6/M5	24,5	M5	4	15	6/4	45	9	8	25
RC-RV-6/01	31,5	G1/8	5,5	23	6/4	310	10	14	25
RC-RV-6/02	38	G1/4	6	26	6/4	420	10	17	25
RC-RV-8/01	31,5	G1/8	5,5	23	8/6	310	12	14	25
RC-RV-8/02	38	G1/4	6	26	8/6	420	12	17	25

* Nominal flow rate at 6 bar

UNIDIRECTIONAL FLOW REGULATOR FOR CYLINDER (OUT)

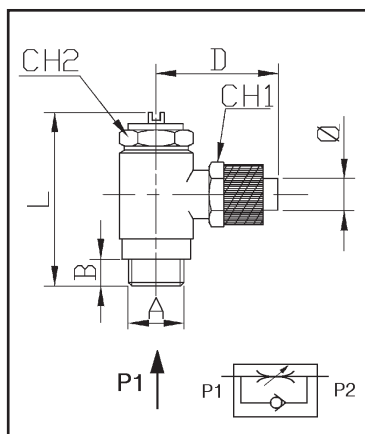

TYPE	L	A	B	D	Ø	NI/min*	CH1	CH2	q.ty
RC-RC-5/M5	24,5	M5	4	15	5/3	45	8	8	25
RC-RC-5/01	34	G1/8	5,5	23	5/3	310	8	14	25
RC-RC-6/M5	24,5	M5	4	15	6/4	45	9	8	25
RC-RC-6/01	31,5	G1/8	5,5	23	6/4	310	10	14	25
RC-RC-6/02	38	G1/4	6	26	6/4	420	10	17	25
RC-RC-8/01	31,5	G1/8	5,5	23	8/6	310	12	14	25
RC-RC-8/02	38	G1/4	6	26	8/6	420	12	17	25
RC-RC-8/03	47	G3/8	7	26	8/6	500	12	20	25

* Nominal flow rate at 6 bar